

1x TECHNISEAL® APPLICATIONS:

- UL/CUL Listed Wet Location
- Cleanroom (Classes 100-100,000; ISO Classes 5-9)
- UL/CUL Hazardous Location (Class I, Division 2; Groups A, B, C & D; Class II, Division 2; Groups F & G)
- NSF Certified Food Processing (Splash Zone, Food Zone)
- Industrial & Commercial
- Transit

BENEFITS:

- Luminaires adaptable to your specific needs

FEATURES:

- Available with **IP 65 rating**, add -IP65 suffix (requires stainless steel lens frame)
- Premium electronic ballast standard
- Available in stainless steel construction
- Every luminaire tested with lamps to assure customer satisfaction
- 5 year limited warranty
- Proudly made in **USA**

SPECIFICATIONS:

HOUSING:

Constructed of nominal 20GA (.036) zinc coated steel for unmatched corrosion protection. Two welded, tapered, threaded flanges on the top provide a sealed wireway access. All seams are sealed with a long life acrylic sealant.

Food Zone: All external metal components of stainless steel (S3 option std).

REFLECTOR:

Fabricated of zinc coated steel, painted with a minimum reflectance of 88%.

LENS FRAME:

Exclusively designed, heavy duty, extruded, anodized aluminum with stainless steel captive screws used to hold the lens frame tight to the housing. The frame is hinged for support while servicing.

Food Zone: All external metal components of stainless steel (S3 option std).

GASKETING:

An extruded, ribbed vinyl gasket seals the lens into the frame; with our exclusive, mechanically held, extruded, silicone gasket used to seal the frame to the housing.

Food Zone: Silicone sealant is used to seal the lens into the frame, with extruded EPDM sealing the frame to the housing.

FINISH:

Painted surfaces are two mil white polyester enamel, special colors available.

LENS:

.140 extruded prismatic acrylic with 50% DR content for durability, smooth side out.

Food Zone: .156 extruded prismatic polycarbonate, smooth side out.

ELECTRICAL:

All ballasts and lampholders are UL Listed.

MOUNTING:

Grid or custom detail available.

TEMPERATURE CODE:

Class I, Div. 2= T5 (100°C); Class II, Div. 2= T5 (100°C)

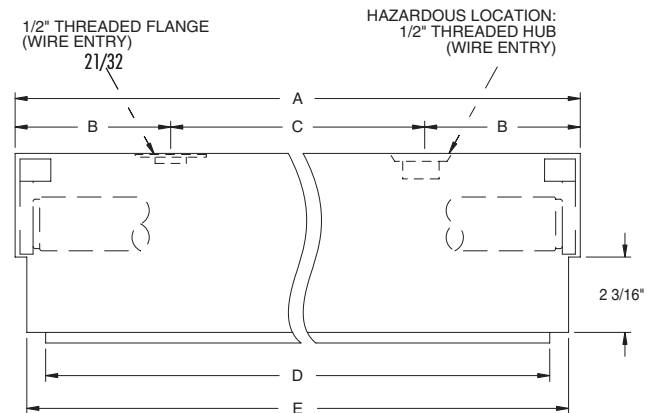
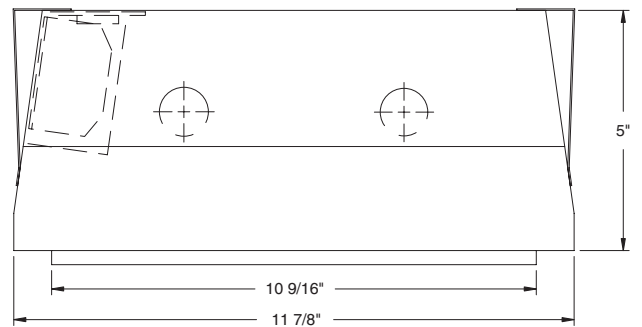

LENGTH	DIMENSIONS IN INCHES				
	A	B	C	D	E
1 FT	11 29/32	5 31/32	—	10 3/4	11 21/32
2 FT	23 29/32	5 11/32	13 1/4	22 3/4	23 21/32
3 FT	35 29/32	6 31/32	22	34 5/8	35 21/32
4 FT	47 29/32	4 31/32	38	46 5/8	47 21/32
6 FT	71 29/32	4 31/32	62	70 5/8	71 21/32
8 FT	95 29/32	4 31/32	86	94 9/16	95 21/32

LENS FRAME DETAILS:

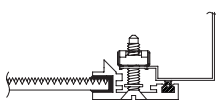

ALUMINUM LENS FRAME DETAIL

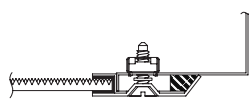

STAINLESS STEEL LENS FRAME DETAIL

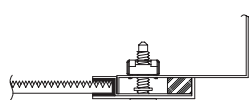

HAZ. LOC. STAINLESS STEEL LENS FRAME DETAIL

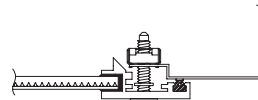

SPLASH ZONE LENS FRAME DETAIL

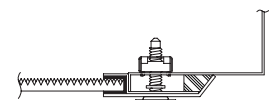

FOOD ZONE LENS FRAME DETAIL



Hazardous Location:



Food Processing:



G1 Series

**PHOTOMETRICS:** For additional photometry, go to paramountlighting.com

Model G12324-R5, 4FT, Specular Reflector and Prismatic Acrylic Lens, 2 32W T8 Fluorescent Lamps, Lamp Lumen Rating = 3050

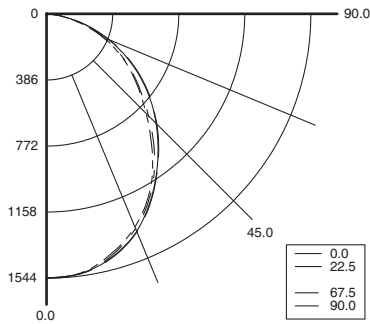

Coefficients of Utilization, Zonal Cavity Method

Floor Cavity Reflectance: 20%

RC	.8			.7			.5			.3			.1			0
RW	.7	.5	.3	.7	.5	.3	.5	.3	.1	.5	.3	.1	.5	.3	.1	0
R 0	74	74	74	74	73	73	73	69	69	66	66	66	64	64	64	62
C 1	68	66	63	61	67	64	62	60	58	59	58	56	57	56	54	53
R 2	62	57	53	50	61	56	53	49	54	51	48	52	49	47	50	48
3	57	51	46	42	56	50	45	41	48	44	41	46	43	40	45	42
4	52	45	40	36	51	44	39	35	43	38	35	41	37	34	40	37
5	48	40	35	31	47	40	34	31	38	34	30	37	33	30	36	32
6	45	36	31	27	43	36	31	27	35	30	27	34	30	26	33	29
7	41	33	28	24	40	33	27	24	32	27	24	31	27	23	30	26
8	39	30	25	21	38	30	25	21	29	24	21	28	24	21	27	24
9	36	28	23	19	35	27	23	19	27	22	19	26	22	19	25	22
10	34	26	21	17	33	25	21	17	25	20	17	24	20	17	24	20

Zonal Lumen Summary

Zone	Lumens	% Lamp	% Luminaire
0-30	1169	19.2	30.5
0-40	1867	30.6	48.7
0-60	3135	51.4	81.8
0-90	3832	62.8	100
90-120	0	0	0
90-130	0	0	0
90-150	0	0	0
90-180	0	0	0
0-180	3832	62.8	100

Total Luminaire Optical Efficiency = 62.8%

Spacing Criterion: 0° = 1.18, 90° = 1.16

1x TECHNISEAL® GRID TROFFER ORDERING INFORMATION:

SERIES	LAMP QTY	LAMP TYPE	LENS	OPT MAT	GRID	OPTIONS	VOLTAGE
G1	Wet Location Cleanroom	1* 2* Standard	2 .125 Clear Acrylic (No Pattern) 3 .125 White Acrylic 4 .140 Prismatic Acrylic (P12) (base) 6 .125 Clear Polycarbonate (No Pattern) 7 .125 White Polycarbonate 8 .156 Prismatic Polycarbonate (P12) 9 .187 Tempered Glass (P62)			EMERGENCY (SPECIFY VOLTAGE) EM2 Bodine BDL700 WET/IOTA I-48-DL WET or similar EM3 Bodine BDL500 WET/IOTA I-320-DL WET or similar EM4 Bodine BDL900 WET/IOTA I-40-DL WET or similar EM8 Bodine BHD65U HAZ. LOC. BALLASTS (SPECIFY VOLTAGE) D1 Lutron Dimming ECO-10 D2 Electronic Dimming D4 < 10% THD (Consult Factory) E0 Low Temp Electronic (N/A T12RS & VHO) E2 2 Electronic Ballasts E3 3 Electronic Ballasts E9 Rapid Start Electronic Ballast FUSING F1 GLR/HLR Fusing (Fast) F2 GMF/HLR Fusing (Slow) LENSING H0 Special Lens (Specify) H2 .150 Extra Heavy Clear Acrylic H3 .150 Extra Heavy White Acrylic H5 .156 C73 Tempered Glass H6 .187 Clear Tempered Glass J0 Lamp Sleeves (Specify Color) J2 .060 Clear Acrylic Overlay J4 .020 White Acrylic Overlay (Lamp Side) J6 .080 Clear Polycarbonate Overlay J7 Louver (Specify) J9 RFI Lens (Specify Pattern) K3 .187 KSH-12 Acri-Tuf Acrylic	120V-277V/60Hz STD 347V/60Hz 50Hz & Other Voltages Available
18BX	F18T5T (13")	0°					
26QD	26W G24Q 4PIN (1FT)	0°					
40BX	F40T5T (2FT)	0°					
50BX	F50T5T (2FT)	0°					
14T5	F14T5 (2FT)	0°					
17*	F17T8 (2FT)	0°					
24T5H	F24T5/HO (2FT)	0°					
25	F25T8 (3FT)	0°					
28T5	F28T5 (4FT)	0°					
31U*	FB31T8/U 1 5/8" (2FT) 2L	0°					
31U6*	FB31T8/U 6" (2FT) 1L Only	0°					
32*	F32T8 (4FT)	0°					
48H	F48T12/HO (4FT)	-20°					
48T8H	F48T8/HO (4FT)	-20°					
54T5H	F54T5/HO (4FT)	0°					
72H	F72T12/HO (6FT)	-20°					
96H	F96T12/HO (8FT)	-20°					
96T8	F96T8 (8FT) (59W)	50°					
96T8H	F96T8/HO (8FT)	-20°					
TANDEM LAMPS							
Tandem lamps are tandem wired							
25	F25T8 (6FT)	0°					
28T5	F28T5 (8FT)	0°					
32	F32T8 (8FT)	0°					
54T5H	F54T5/HO (8FT)	0°					
* Lamp Type Available for Hazardous Location.							
			*S2 Stainless Steel Housing *S3 Stainless Steel Exterior *S5 Stainless Steel Lens Frame Only * Note: If Stainless Steel is ordered, 304 SS Standard 316 SS and other materials available, consult agent.				
			G1 1 1/2" T-Bar G2 2" T-Bar G4 1 & 1 1/2" T-Bar with Flush Lens G5 2" T-Bar with Flush Lens 1 Inch T-Bar Standard				
			Currently manufacturing fixtures for M+W Zander, Armstrong, Gordon & other grid systems, contact factory for details.				
						MISC IP65 IP rated (-SS option required) P9 Special Paint Color (Provide Paint Code & Chip) R5 Specular Aluminum Reflector S1 Special Material (Consult Agent) T3 Tamper Resistant (Hex w/pin STD, Others Avail) V1 External Gasketing V3 No Silicone Sealant Used W4 Inboard Outboard Wiring (Dual Switching) Y5 RFI Suppressors Add hyphens between options	

Other Wattages and Lengths Available, Consult Factory.**NSF Food Processing Note:**

Food Zone (F prefix) luminaires come in DIRECT CONTACT with food. Splash Zone (S prefix) units may become soiled, but are outside the danger of recontamination.

Information subject to change without notice. Lamps supplied by others.

© 2010 Paramount Industries, Inc. P.O. Box 259 Crosswell, MI 48422

Project Information: