

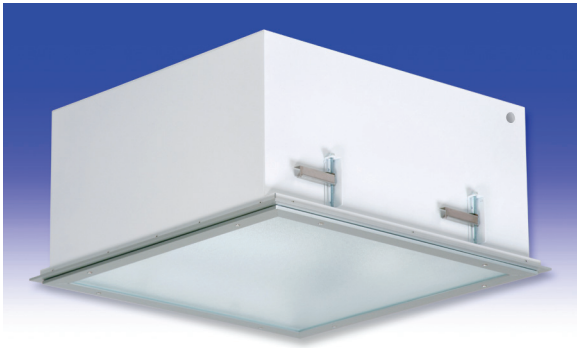

# F8/V6 Series

HID | FLANGE 



### 2x2 HID APPLICATIONS:

- UL/CUL Listed Wet Location
- Cleanroom (Classes 100-100,000; ISO Classes 5-9)
- UL/CUL Hazardous Location (Class I, Division 2; Groups A, B, C & D; Class II, Division 2; Groups F & G)
- NSF Certified Food Processing (Splash Zone, Food Zone)
- Industrial & Commercial

### BENEFITS:

- Luminaires adaptable to your specific needs

### FEATURES:

- Available with **IP 65 rating**, add -IP65 suffix (requires stainless steel lens frame)
- Available in stainless steel construction
- Every luminaire tested with lamps to assure customer satisfaction
- 5 year limited warranty
- Proudly made in **USA**

## SPECIFICATIONS:

### HOUSING:

Constructed of nominal 20GA (.036) zinc coated steel for unmatched corrosion protection. One welded, tapered, threaded flange on the side provides a sealed wireway access. All seams are sealed with a long life acrylic sealant.

### REFLECTOR:

Fabricated of diffuse aluminum.

### LENS FRAME:

Exclusively designed, heavy duty, extruded, anodized aluminum with stainless steel captive screws used to hold the lens frame tight to the housing. The frame is hinged for support while servicing.

**Food Zone:** Lens frame and trim frame of stainless steel (S6 option std).

### GASKETING:

Silicone sealant is used to seal the lens into the frame; with our exclusive, mechanically held, extruded, silicone gasket used to seal the frame to the housing.

**Food Zone:** Adhesive sealant is used to seal the lens into the stainless steel frame, with EPDM sealing the frame to the housing.

### FINISH:

Painted surfaces are two mil of white polyester enamel.

### LENS:

.187 pattern 62 tempered glass.

### Splash and Food Zones:

.187 pattern 62 tempered glass with .080 clear polycarbonate overlay.

### ELECTRICAL:

Core and coil ballast standard. Porcelain mogul base lampholder has a nickel plated screw shell.

### MOUNTING:

Flange or custom detail available.

### TEMPERATURE:

Class I, Div. 2 - T1 (340°C); Class II, Div. 2 - T3B (165°C).

### F8: Horizontal Lamp Position

HAZ. LOCATION: 1/2" THREADED HUB (WIRE ENTRY)

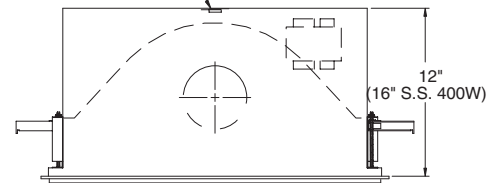

### V6: Vertical Lamp Position

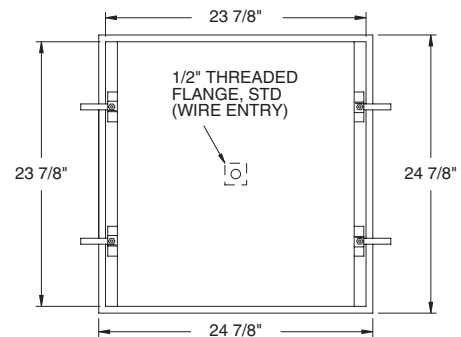
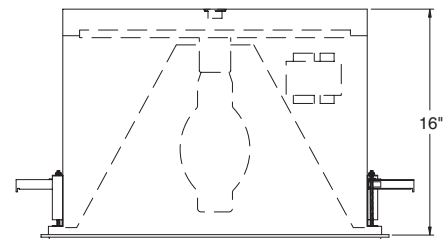

**CEILING CUT-OUT DIMENSIONS:** 24 1/8" x 24 1/8"

### LENS FRAME DETAILS:

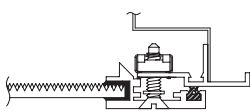

ALUMINUM  
LENS FRAME DETAIL

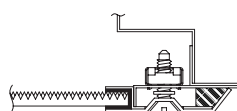

STAINLESS STEEL  
LENS FRAME DETAIL

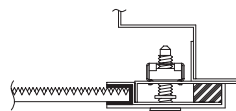

HAZ. LOC. STAINLESS STEEL  
LENS FRAME DETAIL

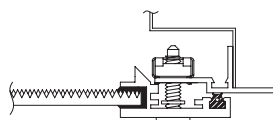

SPLASH ZONE  
LENS FRAME DETAIL

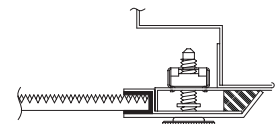

FOOD ZONE  
LENS FRAME DETAIL



Hazardous Location:



Food Processing:



# F8/V6 Series



**PHOTOMETRICS:** For additional photometry, go to [paramountlighting.com](http://paramountlighting.com)

Model F8400M9, Semi-diffuse Reflector and Tempered Glass Lens, 400W BT-37 MH Lamp, Lamp Lumen Rating = 40000

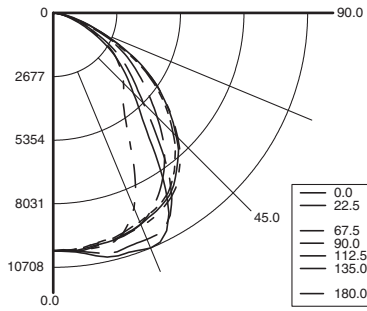

### Coefficients of Utilization, Zonal Cavity Method

Floor Cavity Reflectance: 20%

RC	.8			.7			.5			.3			.1			0		
RW	.7	.5	.3	.1	.7	.5	.3	.1	.5	.3	.1	.5	.3	.1	.5	.3	.1	0
R 0	76	76	76	76	74	74	74	74	70	70	70	67	67	67	65	65	65	63
C 1	70	67	65	63	68	66	64	62	63	61	60	61	59	58	58	57	56	55
R 2	64	59	55	52	62	58	55	52	56	53	50	54	51	49	52	50	48	47
3	59	53	48	44	57	52	47	44	50	46	43	48	45	42	46	44	41	40
4	54	47	42	38	53	46	41	37	45	40	37	43	39	36	42	39	36	35
5	50	42	37	33	49	41	36	33	40	36	32	39	35	32	38	34	31	30
6	46	38	33	29	45	37	32	29	36	32	28	35	31	28	34	31	28	27
7	43	35	29	25	42	34	29	25	33	28	25	32	28	25	31	28	25	24
8	40	32	26	23	39	31	26	23	30	26	23	29	25	22	29	25	22	21
9	37	29	24	20	36	29	24	20	28	23	20	27	23	20	27	23	20	19
10	35	27	22	19	34	26	22	19	26	21	18	25	21	18	25	21	18	17

### Zonal Lumen Summary

Zone	Lumens	% Lamp	% Luminaire
0-30	8168	20.4	32
0-40	13228	33.1	51.9
0-60	21942	54.9	86
0-90	25502	63.8	100
90-120	0	0	0
90-130	0	0	0
90-150	0	0	0
90-180	0	0	0
0-180	25502	63.8	100

Total Luminaire Optical Efficiency = 63.8%

Spacing Criterion: 0° = 1.30, 90° = 1.35

## 2x2 HID FLANGE LUMINAIRE ORDERING INFORMATION:

SERIES	LAMP WATTS	LAMP TYPE	9	OPT MAT	OPTIONS	VOLTAGE
<b>Horizontal Lamp</b> <b>F8</b> Wet Location <b>HF8</b> Hazardous <b>SF8</b> Splash Zone <b>FF8</b> Food Zone <b>Vertical Lamp</b> <b>V6</b> Wet Location <b>SV6</b> Splash Zone <b>FV6</b> Food Zone	<b>150*</b> <b>175*</b> MH only <b>200</b> MH only <b>250*</b> <b>320</b> MH only <b>350*</b> MH only <b>400*</b>	<b>M</b> MH Magul Base <b>S</b> HPS Magul Base	<b>9</b> .187 Tempered Glass (P62) <b>FOOD ZONE ONLY</b> <b>9</b> .187 Tempered Glass (P62) with .080 Clear Polycarbonate Overlay		<b>FUSING</b> <b>F2</b> GMF/HLR Fusing (Slow) <b>LENSING</b> <b>H5</b> .156 C73 Tempered Glass <b>H6</b> .187 Clear Tempered Glass <b>J2</b> .060 Clear Acrylic Overlay (N/A Food Zone) <b>J6</b> .080 Clear Polycarbonate Overlay (Std, Food Zone) <b>J8</b> Wire Guard (N/A Splash Zone/Food Zone) <b>K0</b> .200 V825 Acrylic (N/A Food Zone) <b>K6</b> External Prisms (N/A Splash Zone/Food Zone) <b>MISC</b> <b>IP65</b> IP rated (-S5 option required) <b>P1</b> Zinc Coated Steel Plaster Frame <b>P3</b> Stainless Steel Plaster Frame <b>P9</b> Special Paint Color (Provide Paint Code & Chip) <b>R4</b> Asymmetric Reflector (N/A Vertical Lamp) <b>S1</b> Special Material (Consult Agent) <b>T3</b> Tamper Resistant (Hex w/pin STD, Others Avail) <b>V1</b> External Gasketing (N/A Splash Zone/Food Zone) <b>Y3</b> Quartz Restrike (N/A Hazardous Location)	<b>120V-277V/60Hz STD</b> 208V/60Hz 240V/60Hz 347V/60Hz 480V/60Hz 50Hz Available

\* Lamp Type Available for Hazardous Location.

\*S2 Stainless Steel Housing  
\*S3 Stainless Steel Exterior  
\*S5 Stainless Steel Lens Frame Only  
\*S6 SS Lens Frame & Trim Frame

\* Note:  
If Stainless Steel is ordered,  
304 SS Standard  
316 SS and other materials  
available, consult agent.

**F8 Series requires 16" deep housing when Stainless Steel.**  
**All Vertical Lamp models require 16" deep housing.**  
**Other Wattages Available, Consult Factory.**

**NSF Food Processing Note:**  
Food Zone (F prefix) luminaires come in DIRECT CONTACT with food.  
Splash Zone (S prefix) units may become soiled, but are outside the danger of recontamination.

Information subject to change without notice. Lamps supplied by others.

© 2010 Paramount Industries, Inc. P.O. Box 259 Crosswell, MI 48422

**Project Information:**